

FDEPS 2012, Lecture 1

Two-Dimensional Turbulence in the Atmosphere

Ted Shepherd
Department of Meteorology
University of Reading

- Two-dimensional Euler equations

$$\frac{\partial \omega}{\partial t} + \mathcal{P}(y, w) = 0, \quad w = \tilde{N}^2 y, \quad \mathcal{P}(f, g) = f_x g_y - f_y g_x, \quad u = -y_y, \quad v = y_x$$

- Conservation of energy E and enstrophy Z in nonlinear interactions

$$-\psi \frac{\partial \omega}{\partial t} - y \mathcal{P}(y, w) = 0 \quad \mathcal{P} \quad - \tilde{N} \times (y \tilde{N} y_t) + \frac{\mathcal{P}}{\mathcal{P}t} \left(\frac{1}{2} |\tilde{N} y|^2 \right) - \mathcal{P} \left(\frac{1}{2} y^2, w \right) = 0$$

$$\omega \frac{\partial \omega}{\partial t} + w \mathcal{P}(y, w) = 0 \quad \mathcal{P} \quad \frac{\mathcal{P}}{\mathcal{P}t} \left(\frac{1}{2} w^2 \right) + \mathcal{P} \left(y, \frac{1}{2} w^2 \right) = 0$$

$$\Rightarrow \frac{dE}{dt} = \frac{d}{dt} \iint_{\Omega} |\tilde{N} y|^2 dx dy = 0, \quad \frac{dZ}{dt} = \frac{d}{dt} \iint_{\Omega} w^2 dx dy = 0$$

- The wavenumber spectra are related by $Z(k) = k^2 E(k)$
- Evolution of $E(k)$ is constrained by conservation of both E and Z : *prohibits a direct (downscale) energy cascade*

- Spreading of an *initially localized* energy spectrum

$$\frac{d}{dt} \int (k - k_0)^2 E(k) dk = \frac{d}{dt} \int [k^2 E(k) - 2k k_0 E(k) + k_0^2 E(k)] dk > 0$$

$$\Rightarrow \frac{d}{dt} \int k E(k) dk < 0$$

- Hence energy moves mainly to smaller k , i.e. to larger spatial scales
- Similarly, enstrophy is expected to move mainly to larger k

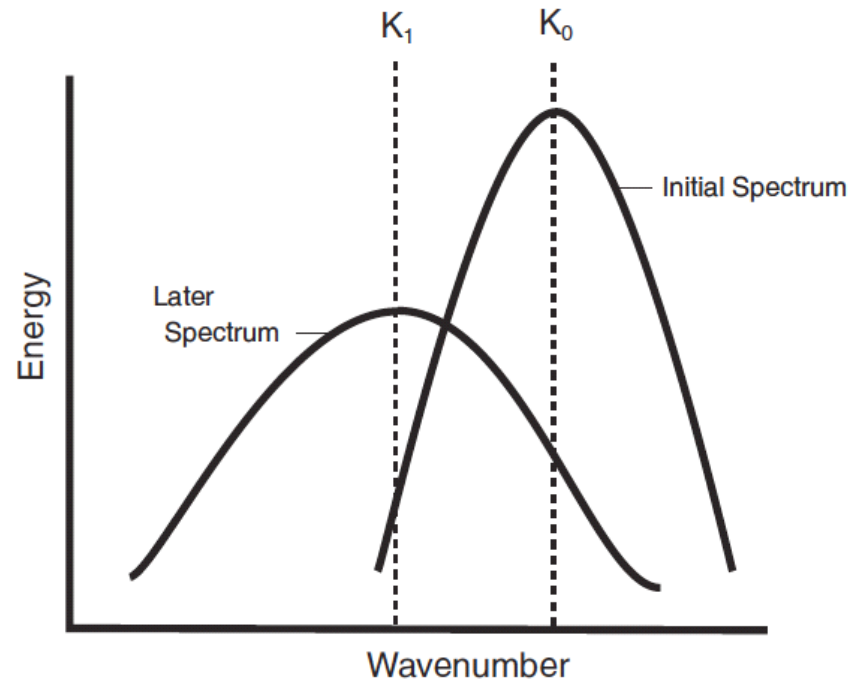

Vallis (2006)

- The classical picture of two-dimensional turbulence (after Kraichnan 1967 Phys. Fluids)
 - Argued to be relevant to the atmosphere by Charney (1971 JAS)

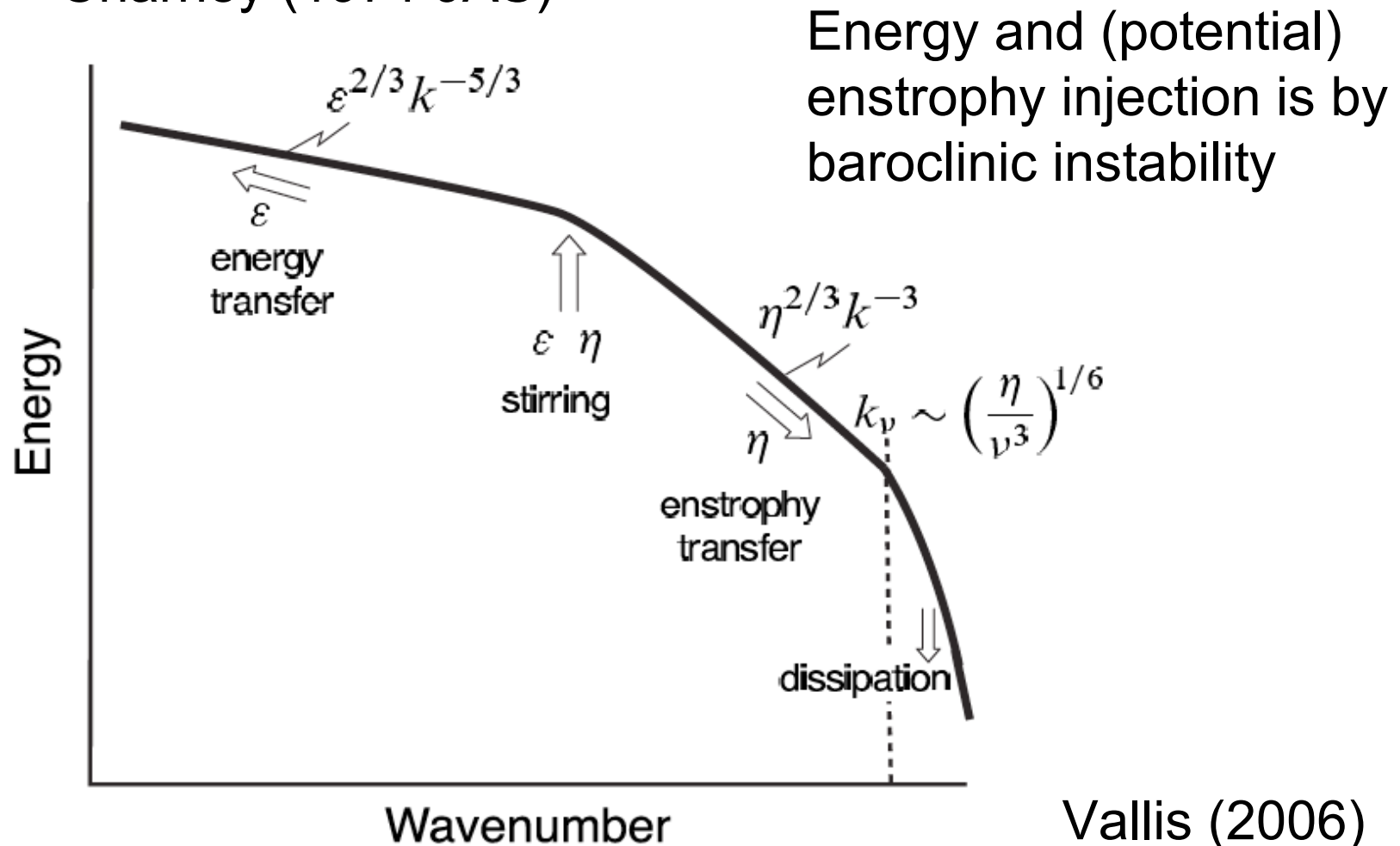

J. Atmos. Sci. (1983)

Large-Scale Two-Dimensional Turbulence in the Atmosphere

G. J. BOER AND T. G. SHEPHERD

Canadian Climate Centre, Downsview, Ontario M3H 5T4 Canada

(Manuscript received 14 May 1982, in final form 13 September 1982)

- Motivation: Understand how to parameterize nonlinear interactions with unresolved scales in a climate model
- Two distinct wavenumber regimes identified:
 - $n < 8$: Stationary, zonally anisotropic, seasonally dependent, no power law, upscale energy cascade
 - $n > 8$: Transient, isotropic, universal, n^{-3} energy spectrum, downscale enstrophy cascade
- Questions:
 - What is the reason for the upscale energy cascade?
 - Why is the n^{-3} energy spectrum so clean?

Kinetic energy spectra from FGGE data

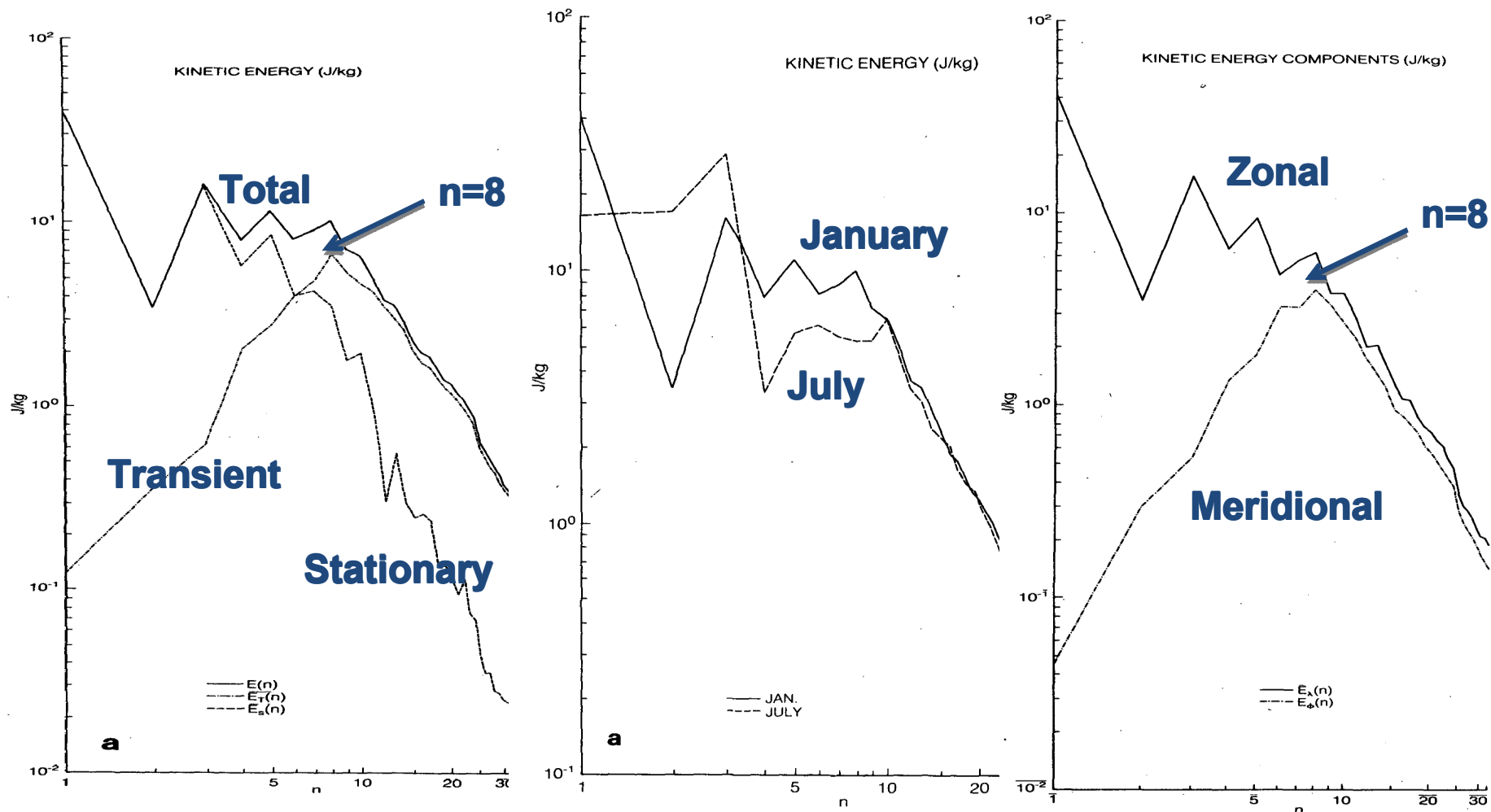

Horizontal axis is spherical harmonic index ($n=1-32$)

Boer & Shepherd (1983 JAS)

The kinetic energy displays a notable maximum at all levels at wavenumber 3. A secondary maximum at wavenumber 8 is also of note and occurs at the wavenumber of the maximum of the transient component, although the contribution to the total kinetic energy from the stationary component is still appreciable.



Boer & Shepherd (1983 JAS)

- The spectral fluxes can be decomposed into stationary (dash-dot), transient (dashed), and mixed stationary-transient (dotted) components

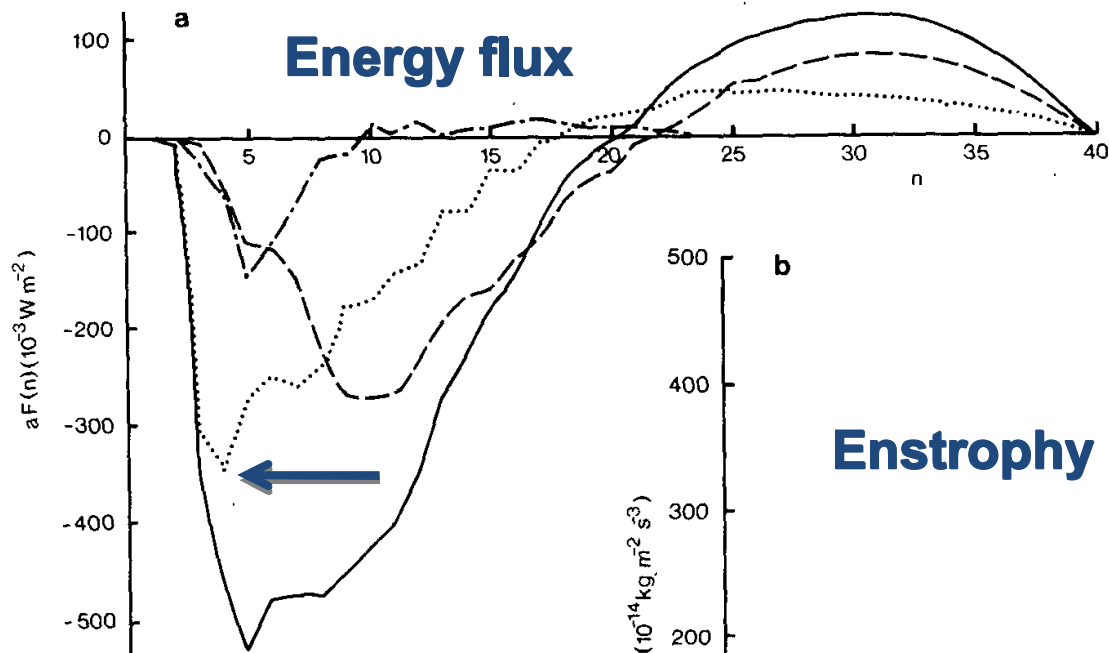

The mixed component is a very significant part of both the energy and the enstrophy fluxes

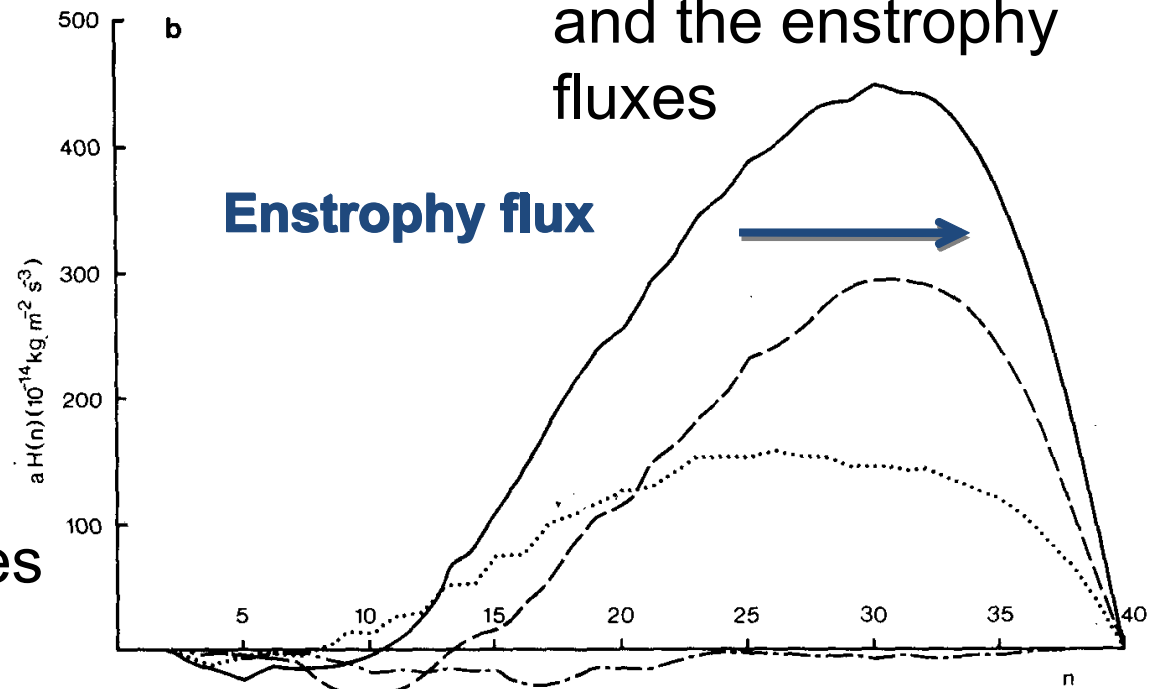

However these fluxes are clearly not well resolved by this data

Shepherd (1987 JAS)

- Assuming 2-D turbulence, Leith (1971 JAS) represented the interactions with unresolved scales as an effective diffusion with a negative spectral range, giving zero energy loss (right)

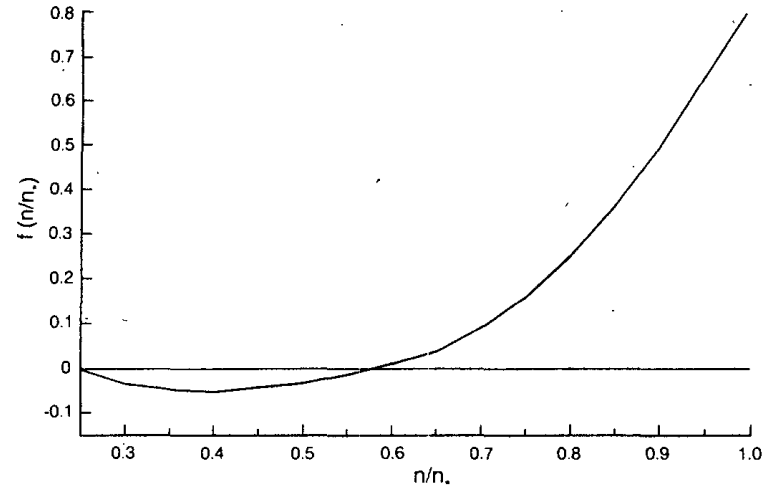

- Applying this to the FGGE data gave estimated total energy and enstrophy fluxes which were consistent with theory

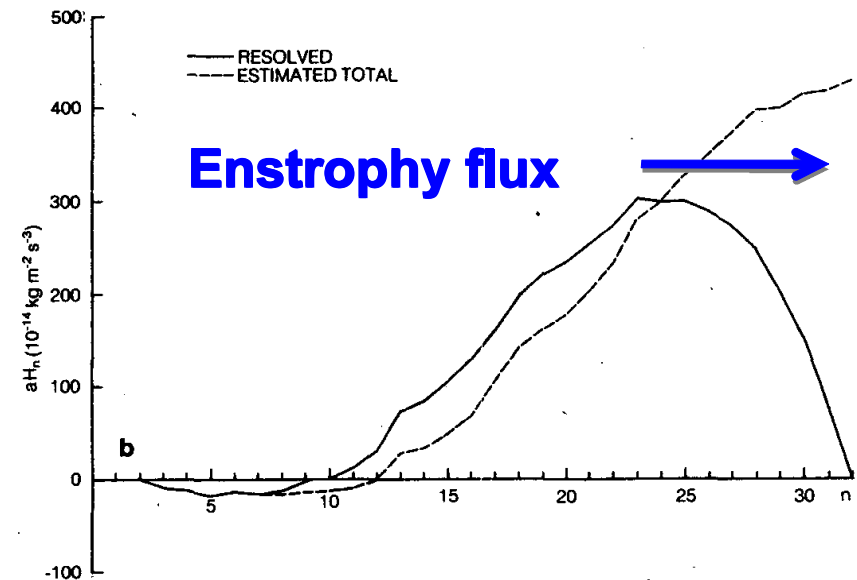
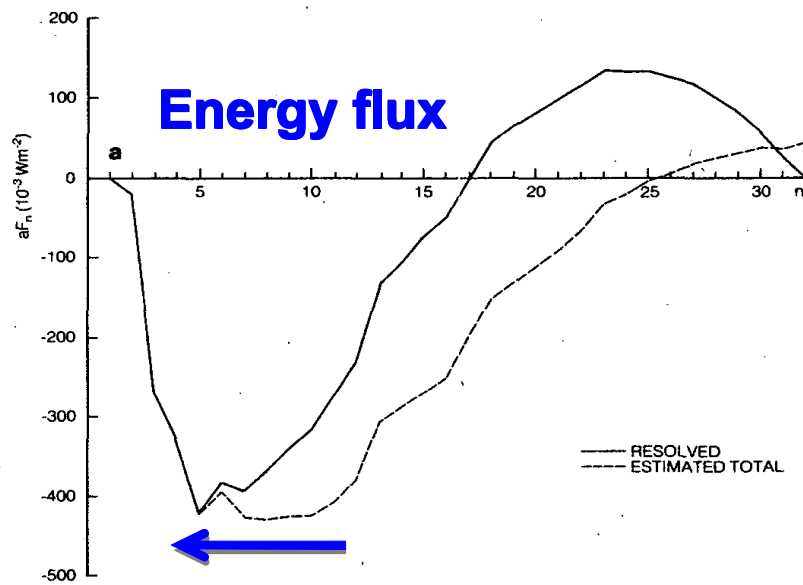

Boer & Shepherd (1983 JAS)

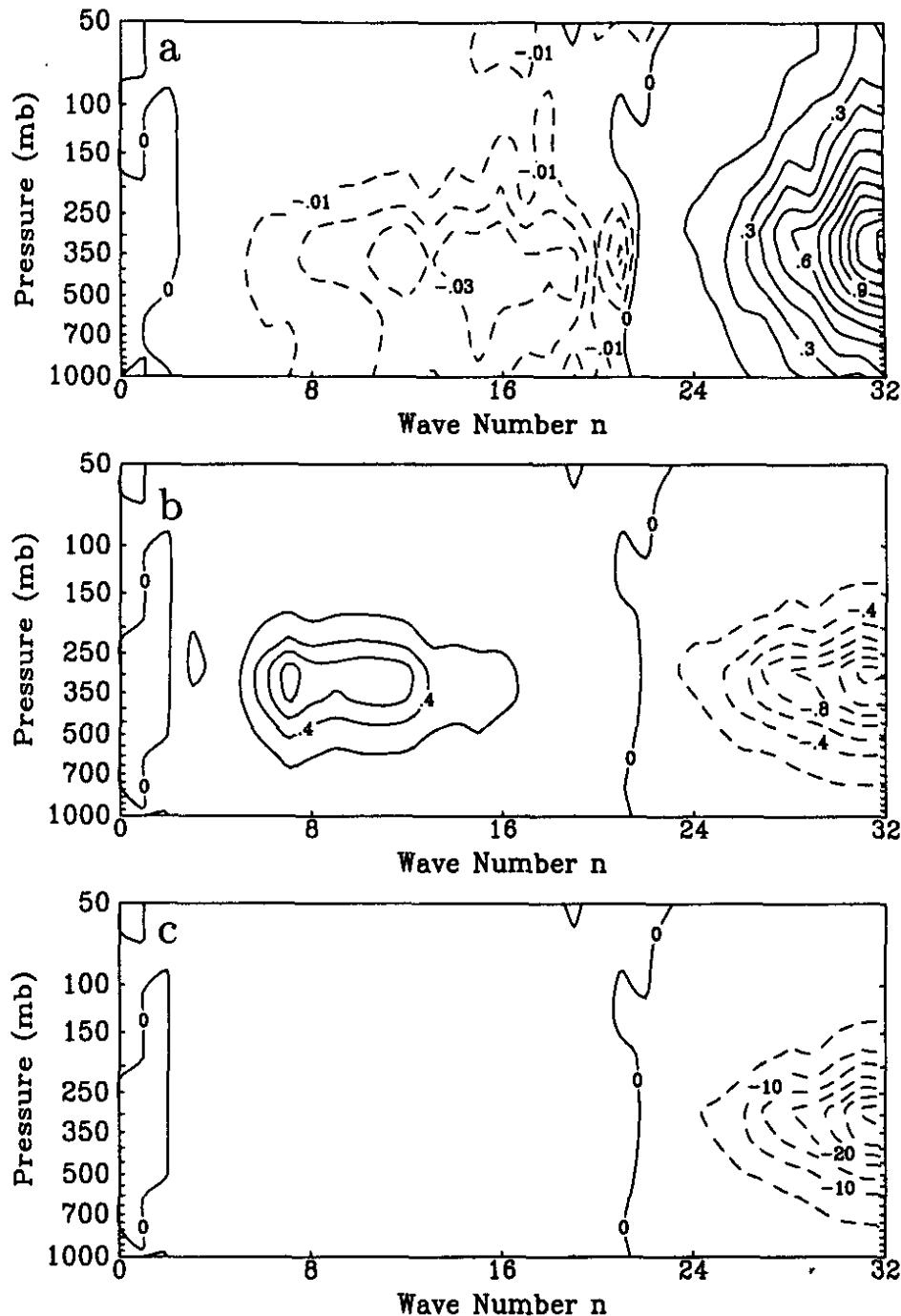

- Using higher-resolution analyses (here ECMWF truncated to T60), the “Leith function” can be estimated for $n=0-32$ (top panel; note factor of 10 difference in positive and negative C.I.’s)
- Lower panels show the corresponding energy and enstrophy interactions with the scales smaller than $n=32$
- Note energy “backscatter”

Koshyk & Boer (1995 JAS)

- The T799 ECMWF operational analysis from January 2008 appears to resolve the fluxes at 250 hPa
 - Baroclinic excitation occurs over $n=10-30$
 - Well defined downscale enstrophy flux

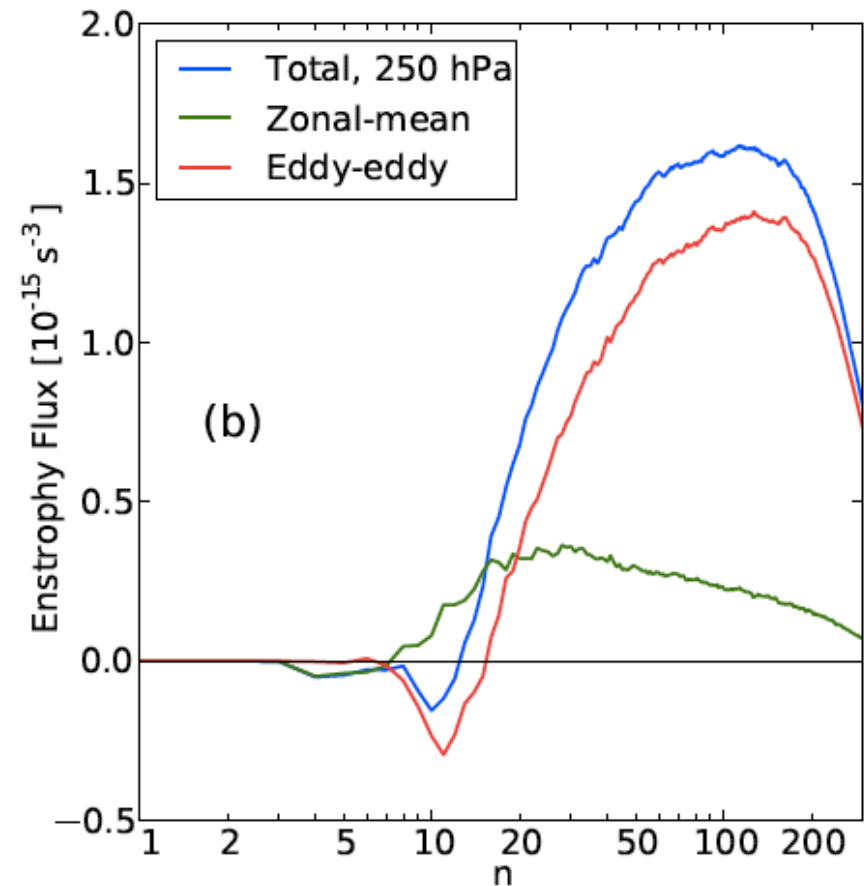
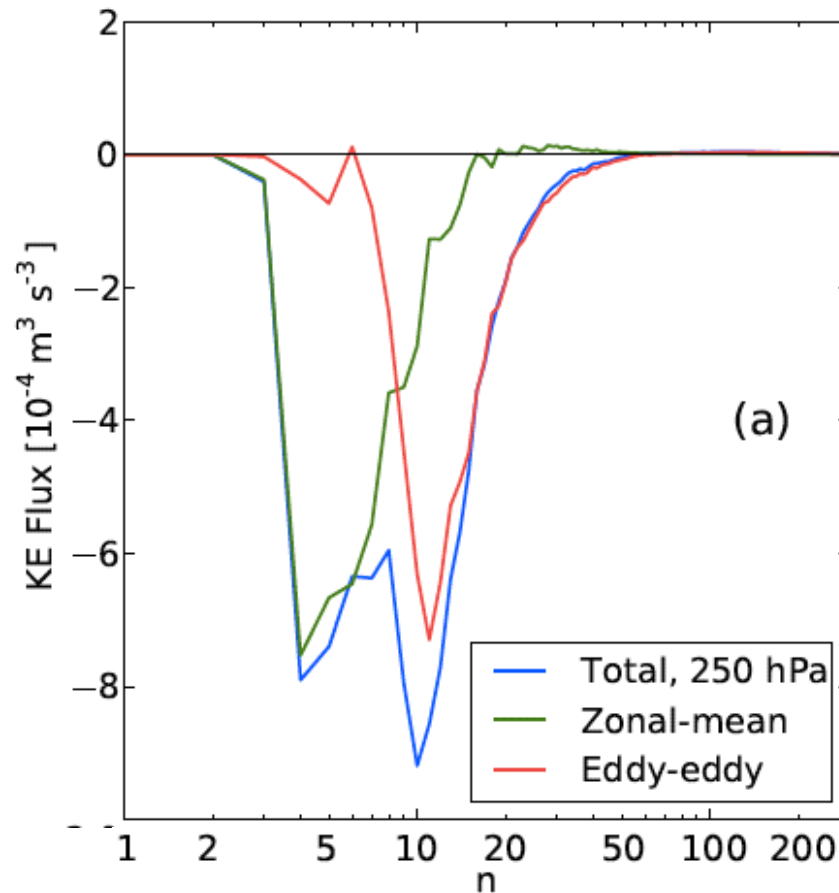

Burgess, Erler & Shepherd (JAS, in press)

- The upscale kinetic energy cascade mainly occurs in the upper troposphere, as two distinct peaks

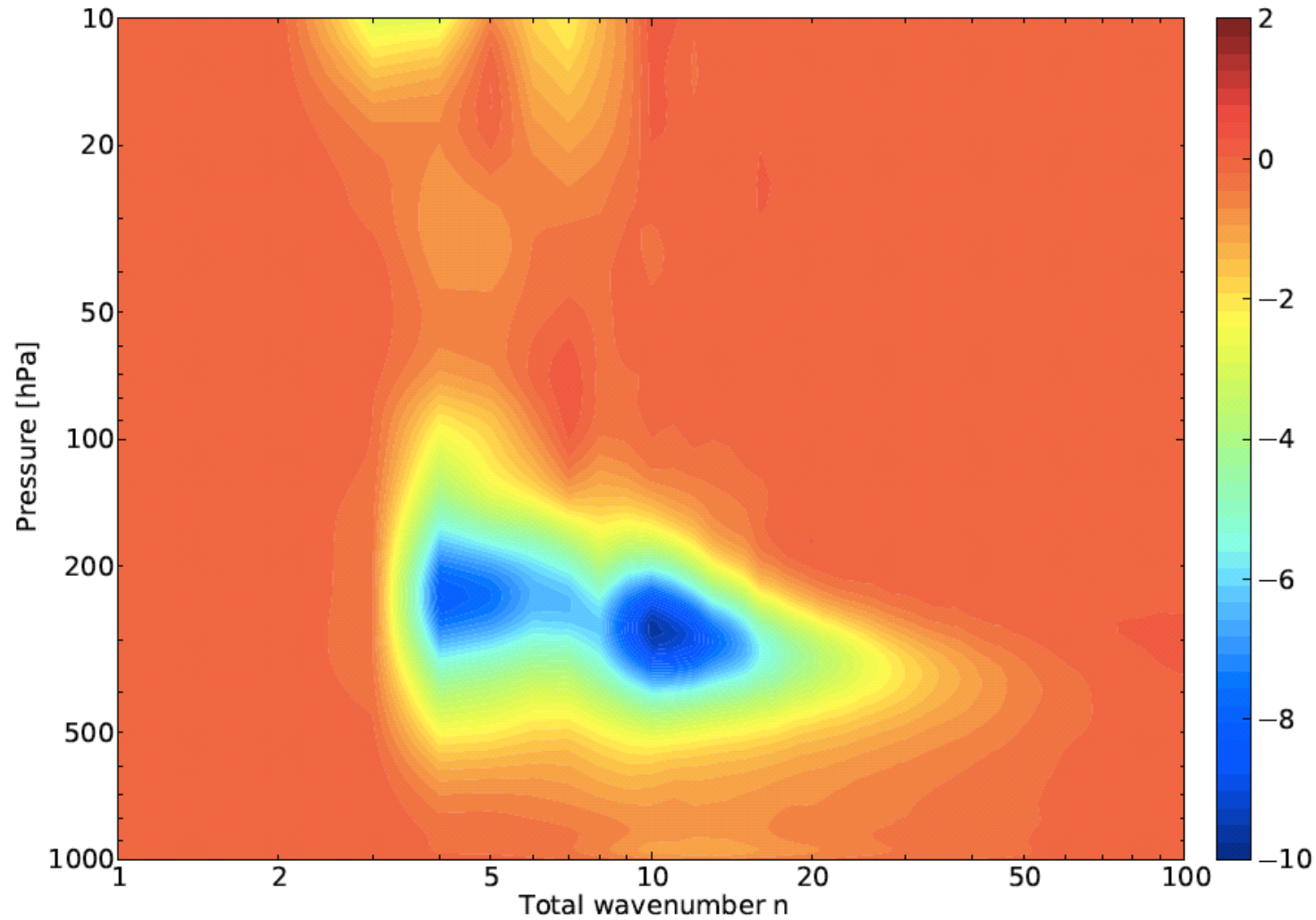

Burgess, Erler & Shepherd (JAS, in press)

- Schneider & Walker (2006 JAS) argue that the limited transient upscale energy cascade is no accident
 - Atmosphere adjusts towards weak nonlinearity (i.e. most-unstable scale equals energy-containing scale)
- A more extensive upscale energy cascade is found in the ocean (Scott & Wang 2005 JPO; Schlosser & Eden 2007 GRL)

Why is the mixed (stationary-transient) component of the atmospheric energy flux upscale?

- The textbook arguments for an upscale energy cascade have lots of loopholes (see Holloway 2010 J. Turb.)
 - Moreover they are not relevant to this situation, which involves spectrally non-local wavenumber triads

- In general, some disturbances will extract energy from a large-scale flow (downscale energy flux; the “Orr effect”), and some will give energy up (upscale energy flux)

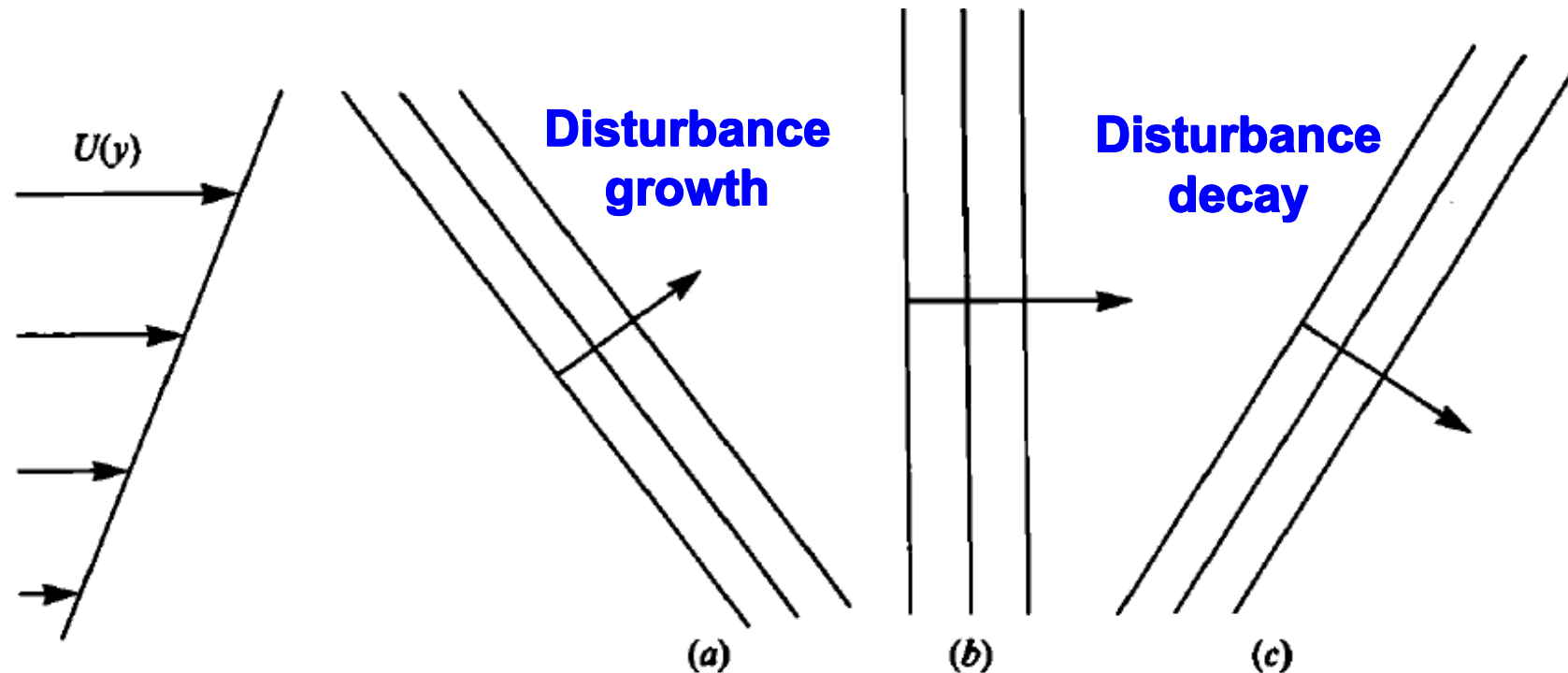

Shepherd (1987 JFM)

- An *initially random* collection of disturbances evolving linearly in the presence of pure strain (Kraichnan 1976 JAS) or pure shear (Shepherd 1985 JAS) will exactly conserve its energy, implying *zero net energy exchange* with the background flow
- Nonlinearity leads to net disturbance *growth*

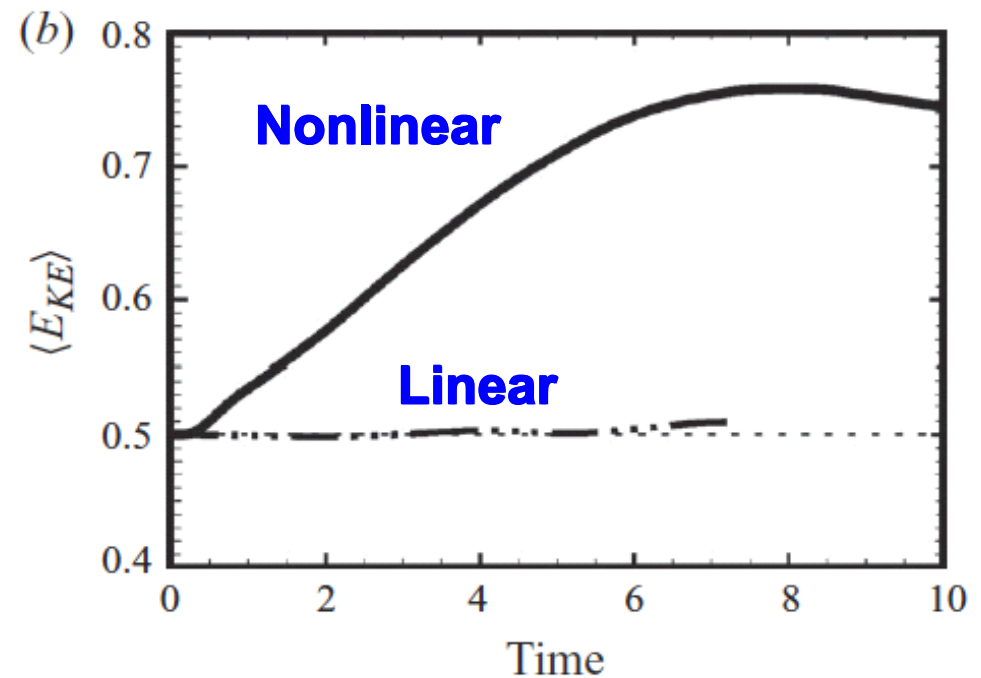
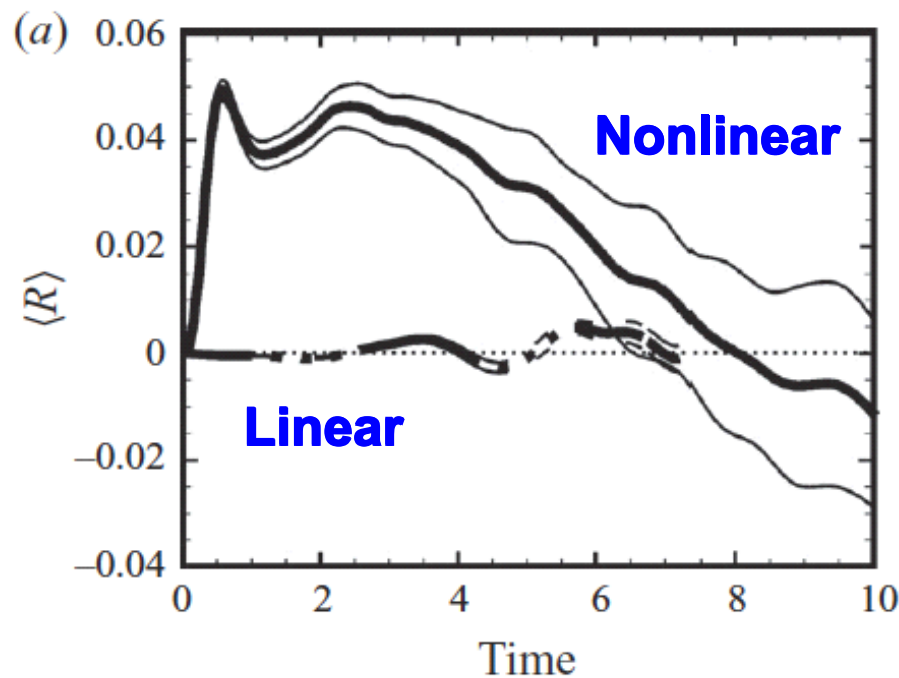

Cummins & Holloway (2010 JFM)

- In the real atmosphere, the transient planetary waves extract energy from the zonal mean flow, while the synoptic-scale waves give energy up to the mean flow – cf. Lorenz & Hartmann (2001 JAS)
- The synoptic-wave contribution dominates; this is what gives the net upscale energy transfer

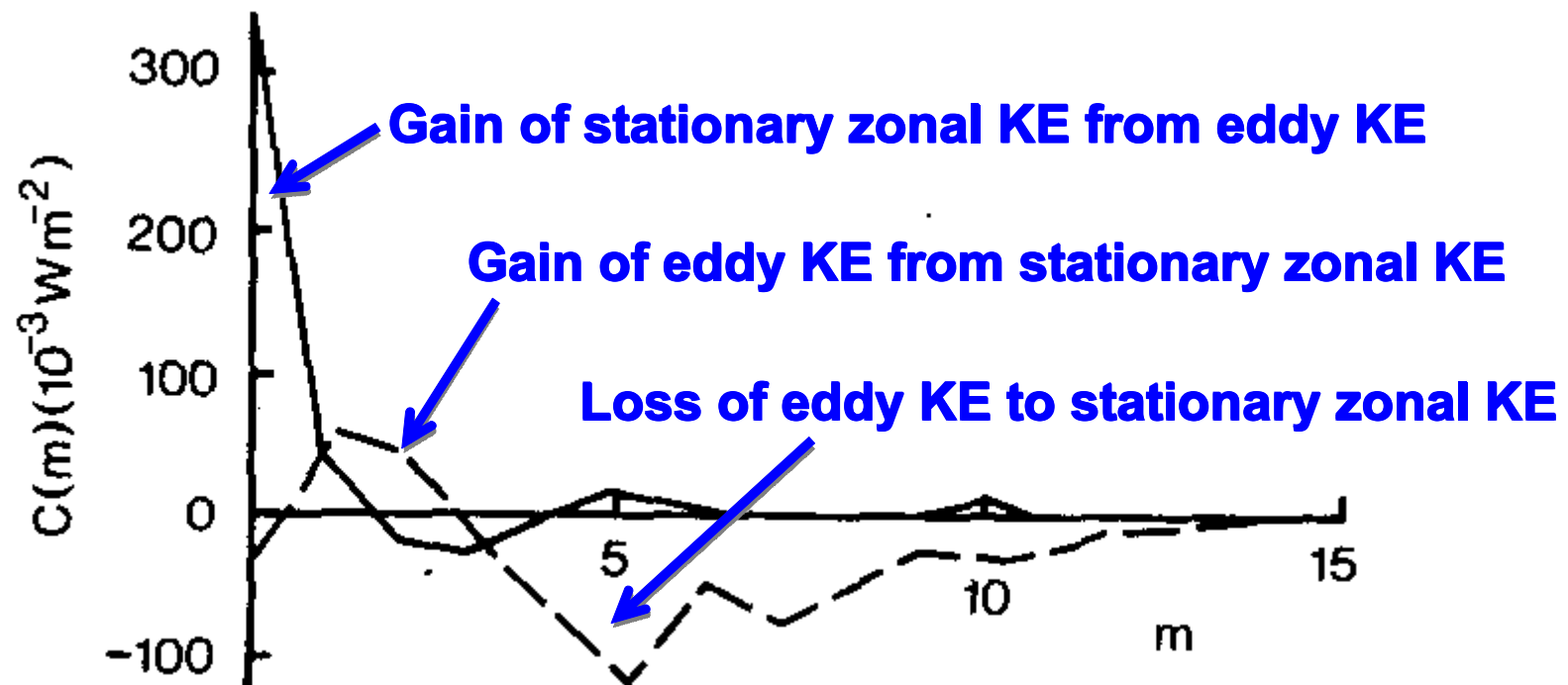

FGGE analysis in Shepherd (1987 JAS)

- The net transfer of kinetic energy from the eddies back to the mean flow is reflected in the Lorenz energy cycle

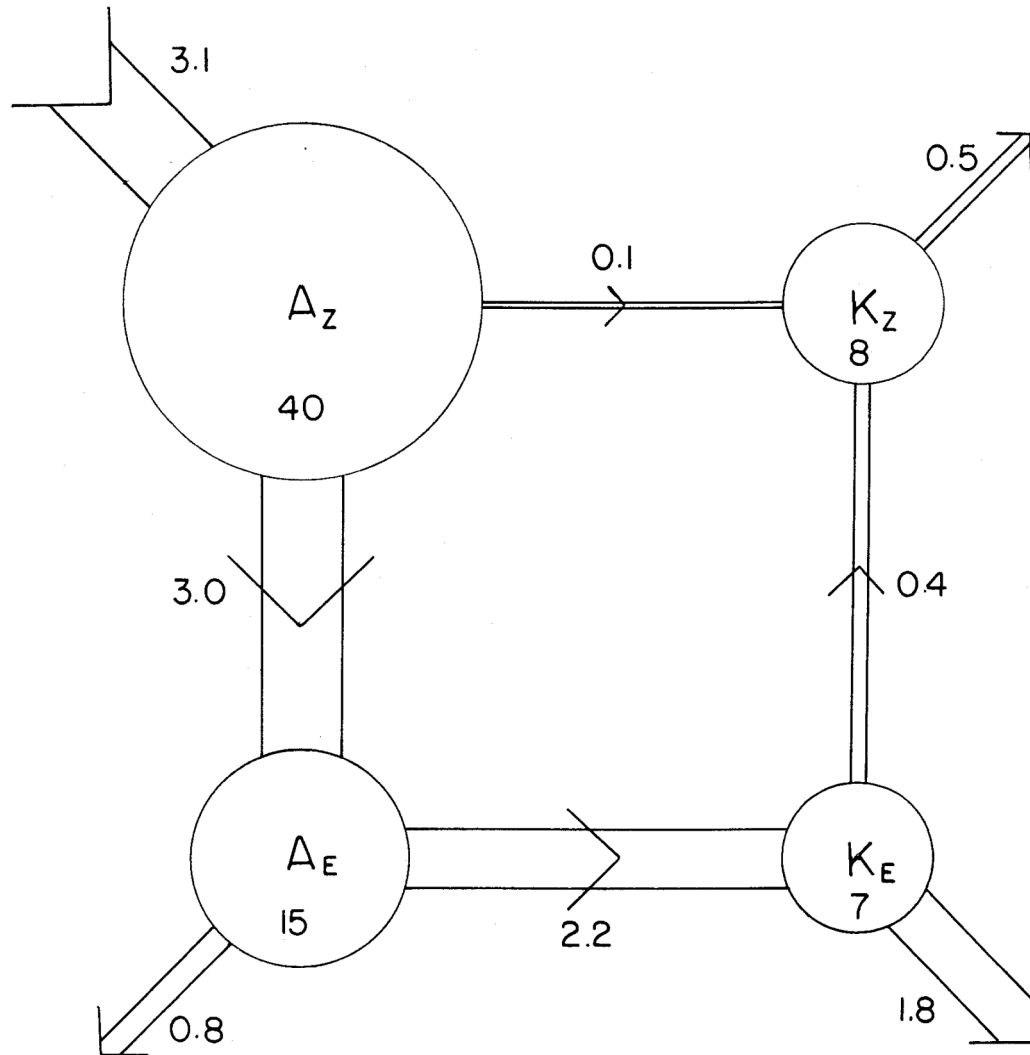

But the $K_E \rightarrow K_Z$ term is not particularly well constrained theoretically

(and anyway the total energy transfer is from the mean flow to the eddies!)

Oort's calculation, in Lorenz (1967)

- Also reflected in the fact that horizontal eddy momentum fluxes are directed into the jet cores, i.e. upgradient

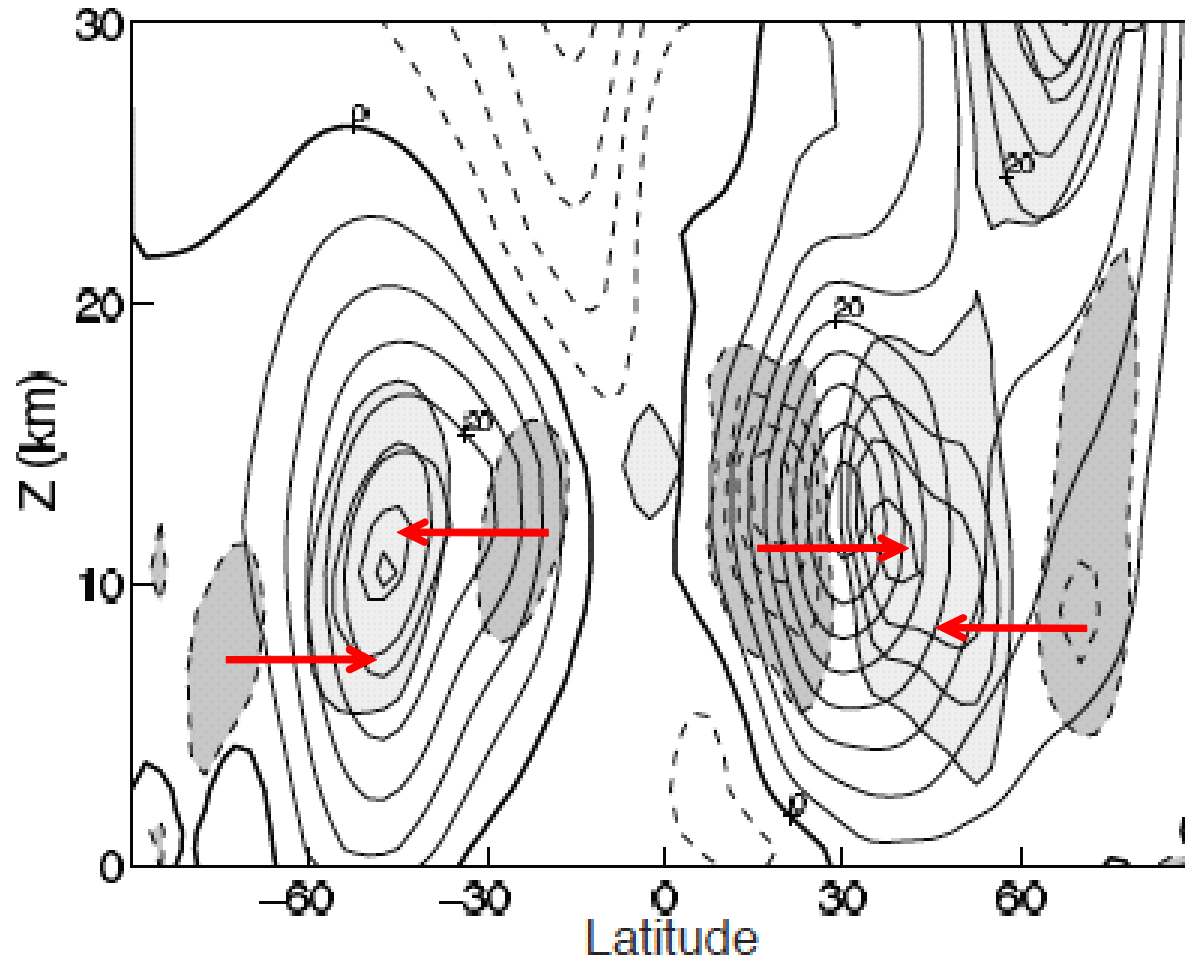

Shading is the eddy horizontal momentum flux convergence (DJF conditions)

Contours are zonal wind

Vallis (2006)

Perfect alignment in SH where jet is eddy driven

Not perfect alignment in NH where jet involves Hadley circulation

- Since horizontal momentum flux is the negative of horizontal Eliassen-Palm flux, momentum fluxes *into* the jet arise from Rossby-wave propagation *out* of the jet, as expected from baroclinic instability (Held & Hoskins 1985 Adv. Geophys.)

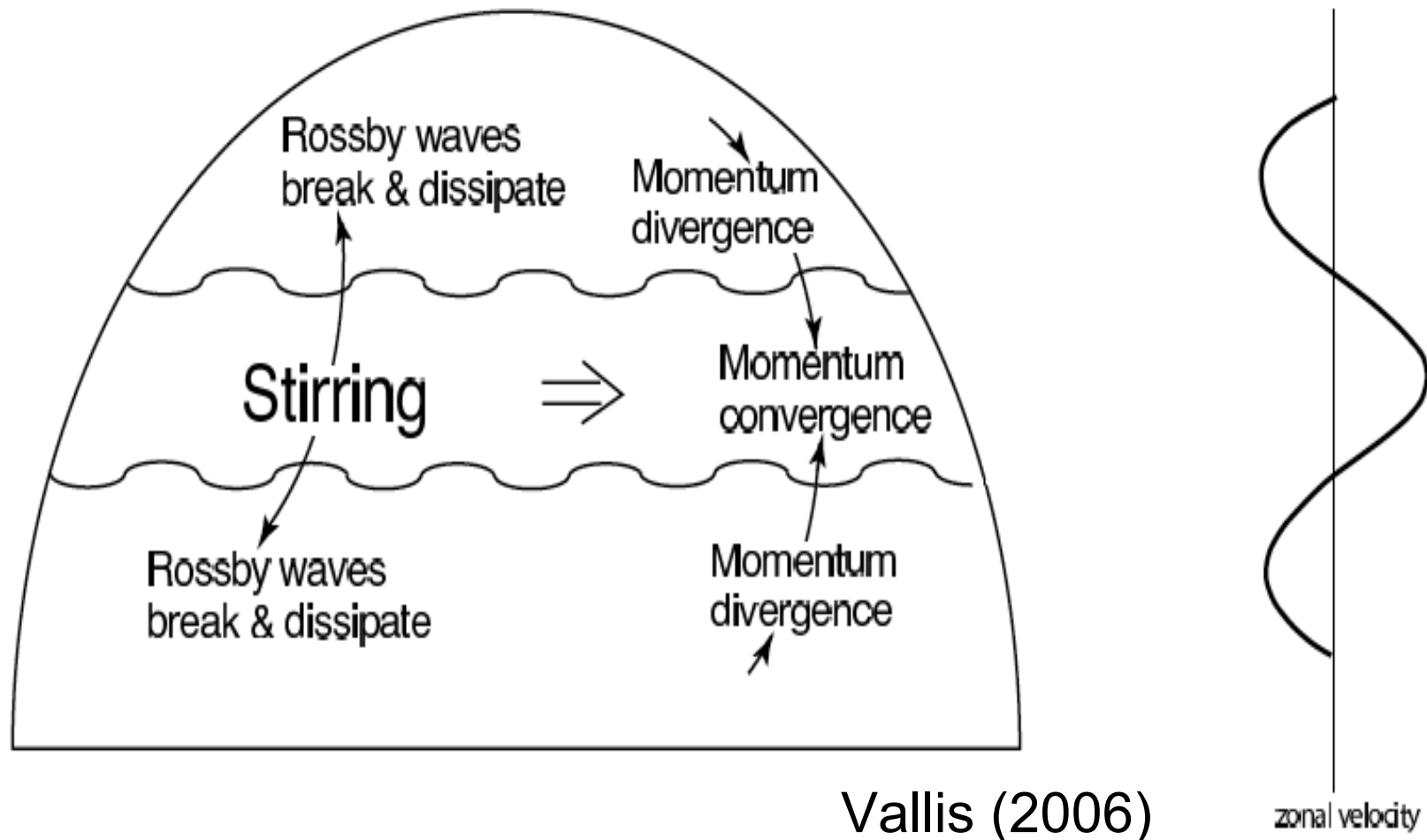

- This phenomenon (originally explained by G.I. Taylor in 1917!) is seen in laboratory rotating-tank experiments
 - A prograde jet emerges from random stirring, surrounded on either side by retrograde jets (seen in distortion of dye)

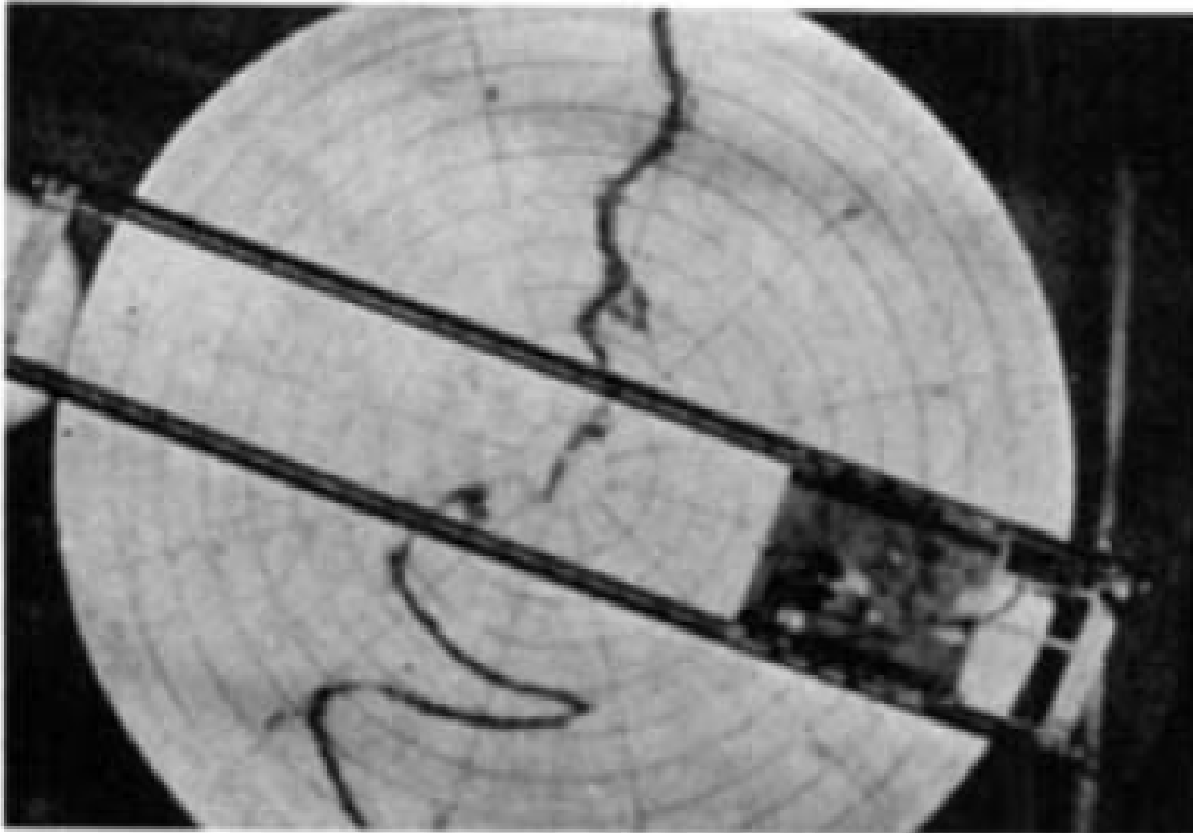

Was proposed
as analogue of
“moving flame”
effect

Whitehead
(1975 Tellus)

- But if the jets are not eddy-driven, then it's not clear that the eddies have to maintain them
- In numerical simulations with an imposed jet and random forcing, the sign of the eddy-mean energy transfer depends on the parameter regime

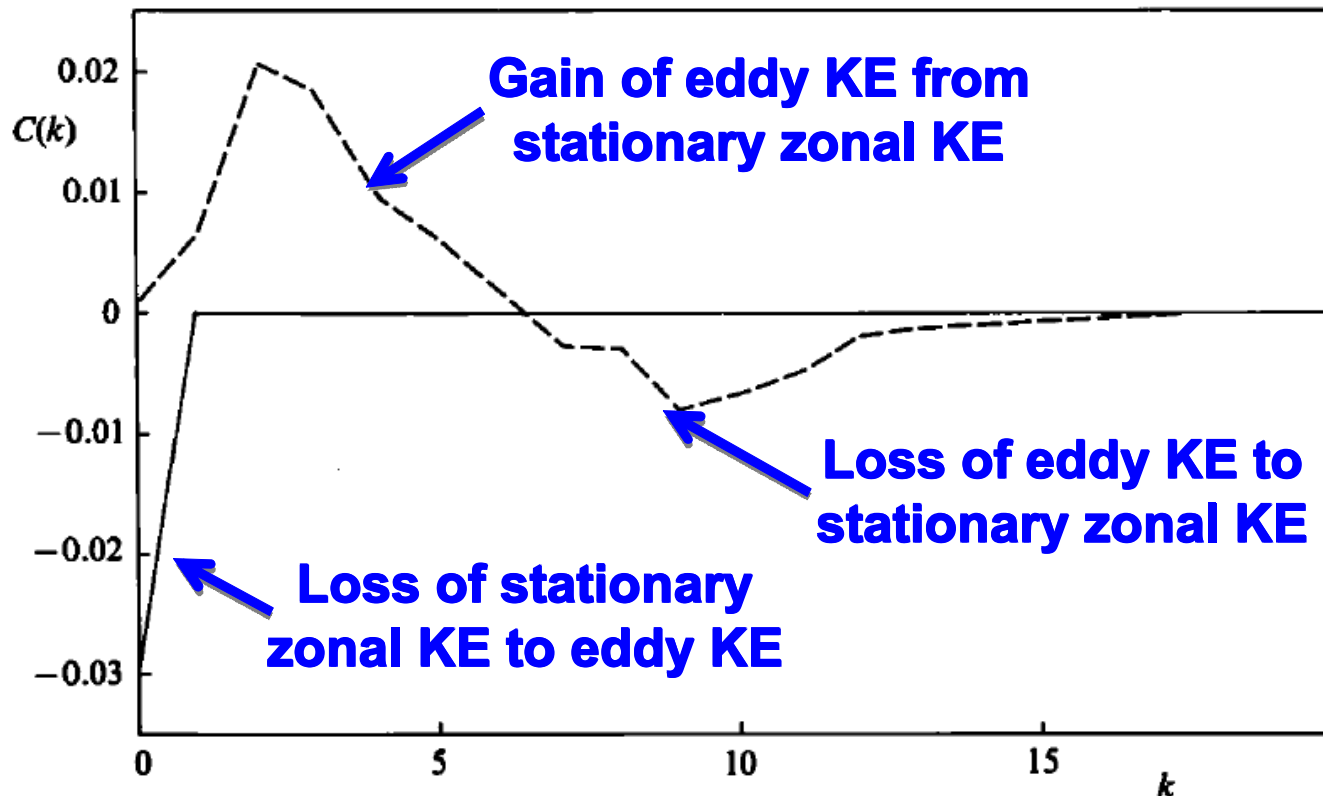

Barotropic numerical simulations in Shepherd (1987 JFM)

Why is the n^{-3} energy spectrum so clean?

- Ironically, the n^{-3} spectrum long proved elusive in ideal 2-D turbulence simulations, but seems to be robust at sufficiently high resolution (30,000 x 30,000) with no large-scale damping (Vallgren & Lindborg 2011 JFM)

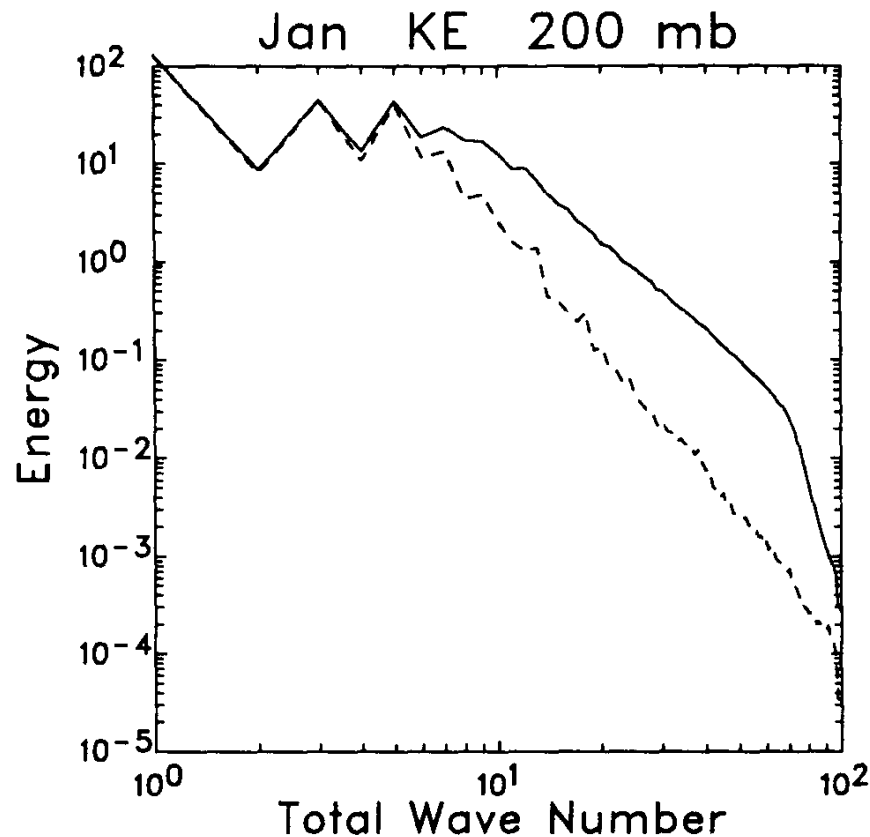

- Yet it has been very robust in atmospheric observations and models!
- Figure shows spectrum from ECMWF operational analysis at T106

Trenberth & Solomon
(1993 MWR)

- An n^{-3} spectrum (for eddy KE) is also found (though less cleanly) in an idealized GCM with wave-wave interactions suppressed

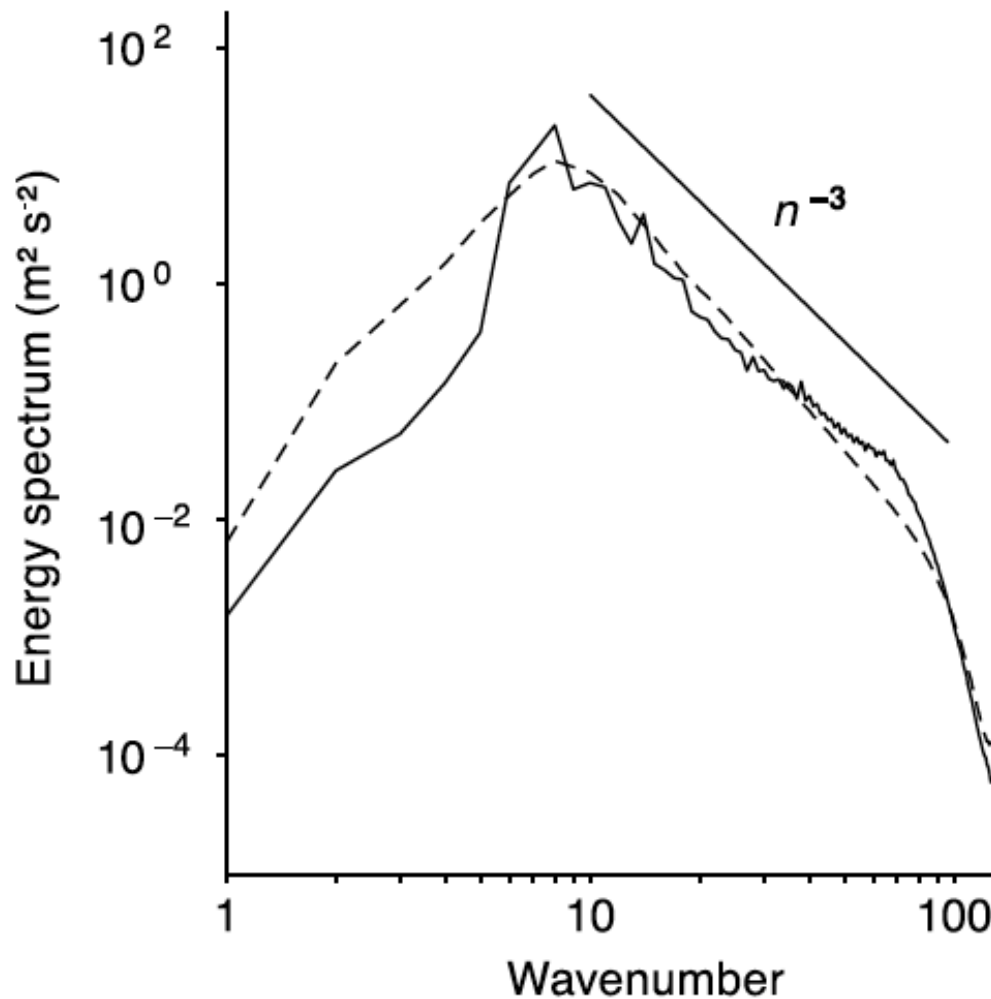

Eddy KE

Dashed: Nonlinear simulation

Solid: Wave-wave interactions suppressed (scaled)

O’Gorman & Schneider (2007 GRL)

- However, the wave-wave interactions strongly affect the wave-mean interactions, which are spectrally non-local (Shepherd 1987 JAS; Huang & Robinson 1998 JAS)

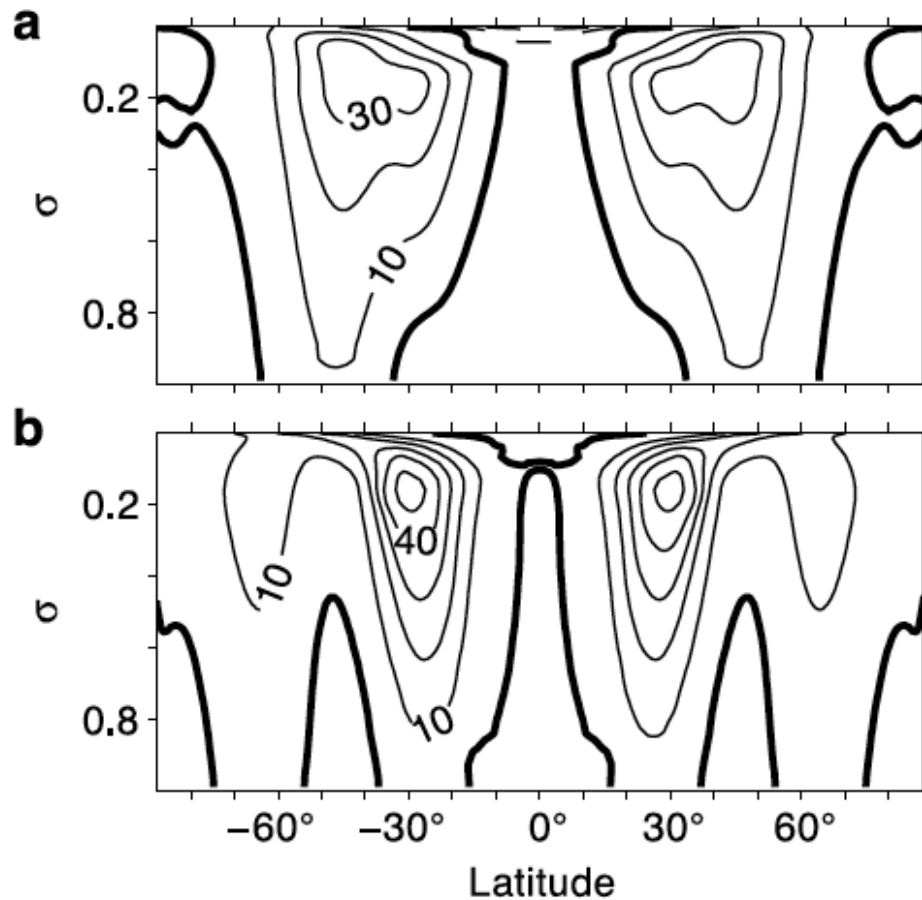

Zonal mean zonal wind

**Nonlinear
simulation**

**Wave-wave
interactions
suppressed**

O’Gorman &
Schneider (2007
GRL)

- Upper tropospheric aircraft observations revealed a $k^{-5/3}$ energy spectrum at scales from about 5-500 km

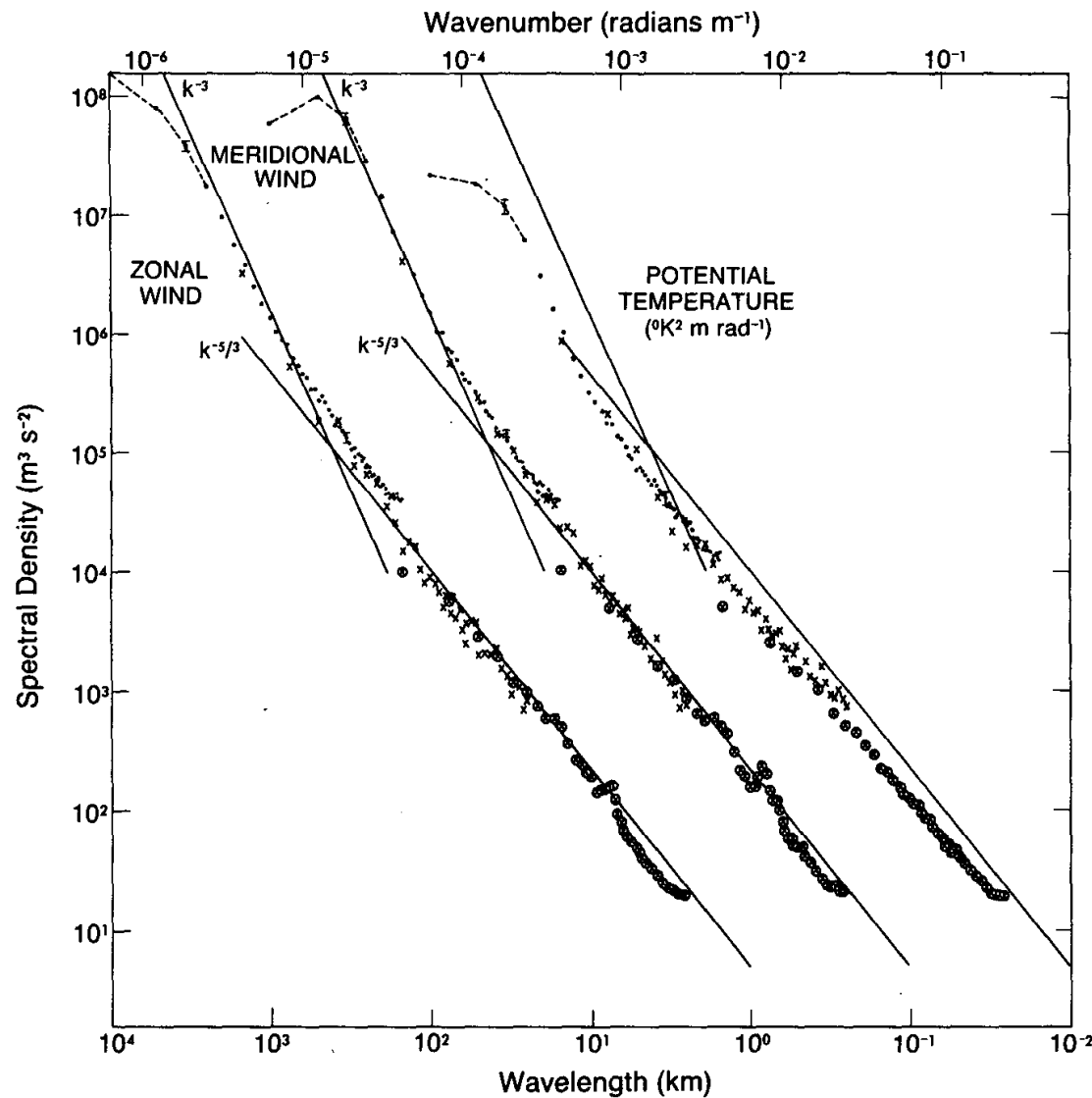

So for the parameterization problem we actually need to understand the dynamics of *this* range

Nastrom & Gage
(1985 JAS)

- The Gage-Nastrom spectrum (blue) is reproduced in high-resolution GCMs (here AFES T639 at 45°N and 200 hPa)

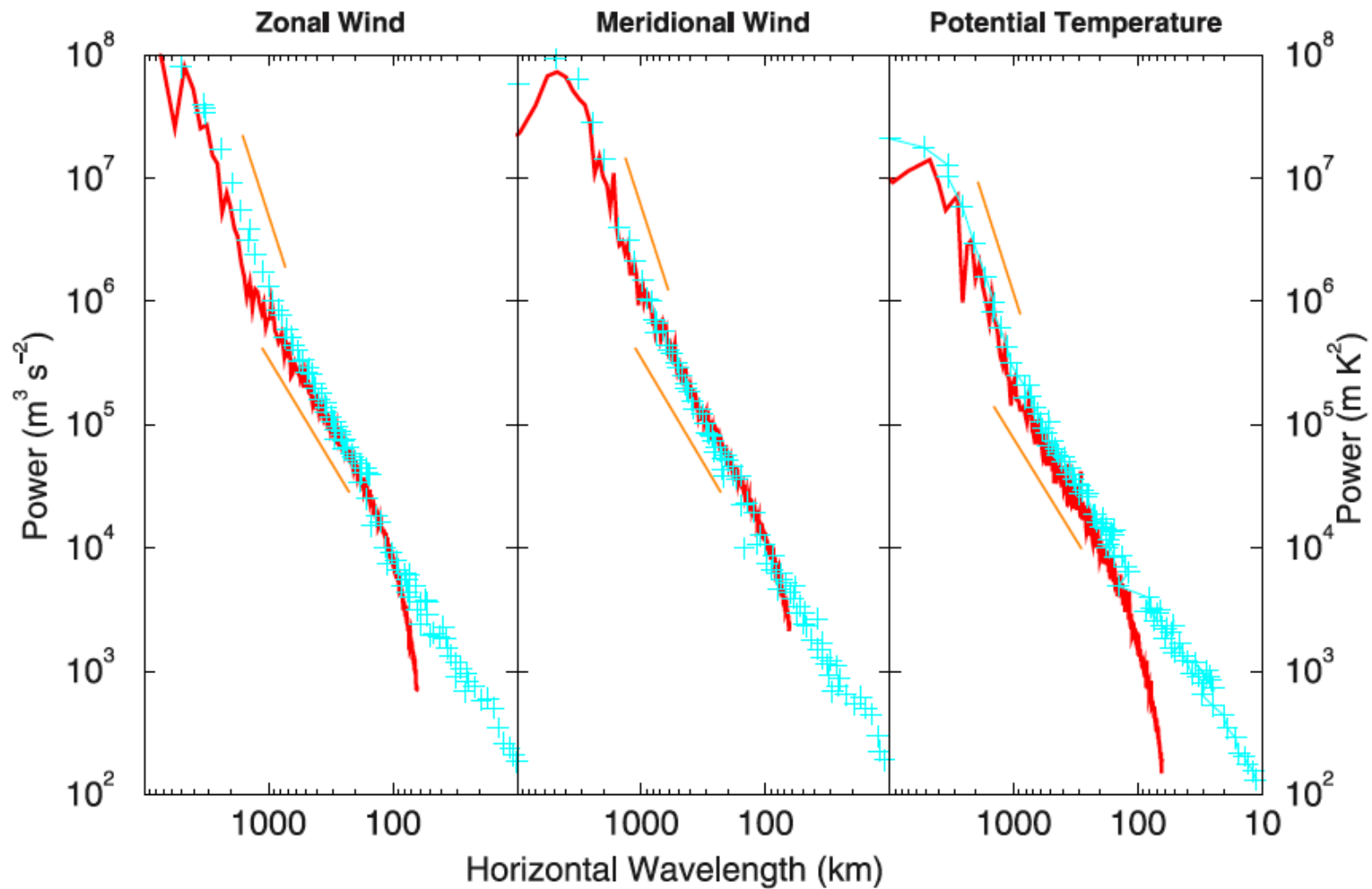

Hamilton, Takahashi & Ohfuchi (2008 JGR)

- The origin of the Gage-Nastrom spectrum has been a matter of considerable controversy
 - Some (e.g. Lilly 1983 JAS) have argued for an inverse cascade of balanced (low Froude number) energy from the mesoscale (2-D turbulence)
 - However, evidence appears to be consolidating around a forward (downscale) cascade of unbalanced energy, uninhibited by the potential enstrophy constraint (e.g. Waite & Bartello 2004 JFM; Lindborg 2006 JFM)
 - Cho & Lindborg (2001 JGR) inferred a forward cascade from analysis of third-order structure functions using the aircraft data
 - Consistent with spontaneous generation of small-scale unbalanced motion from balanced flow (Waite & Bartello 2006 JFM; Skamarock 2004 MWR)

- Also consistent with analysis of high-resolution GCM results (Koshyk & Hamilton 2001 JAS), and with the existence of a $k^{-5/3}$ energy spectrum in aircraft observations around 21 km (Bacmeister et al. 1996 JGR)
- Even low-resolution GCMs exhibit an unbalanced spectrum, which emerges at sufficiently high altitudes

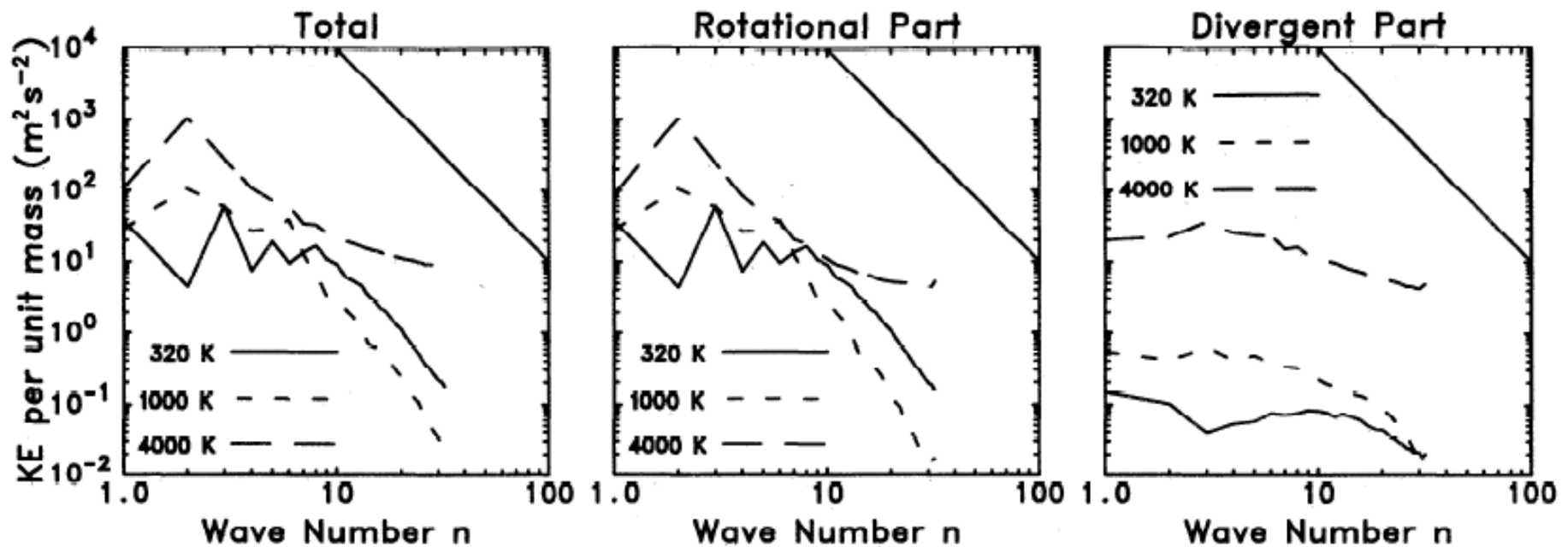

CMAM results from Shepherd, Koshyk & Ngan (2000 JGR)

- The ECMWF operational analysis at T799 from the IPY period (here January 2008) reveals a shallow mesoscale kinetic energy spectrum, emerging above 230 hPa
 - N.B. $n=20$ corresponds to a wavelength of $\lambda = 2000$

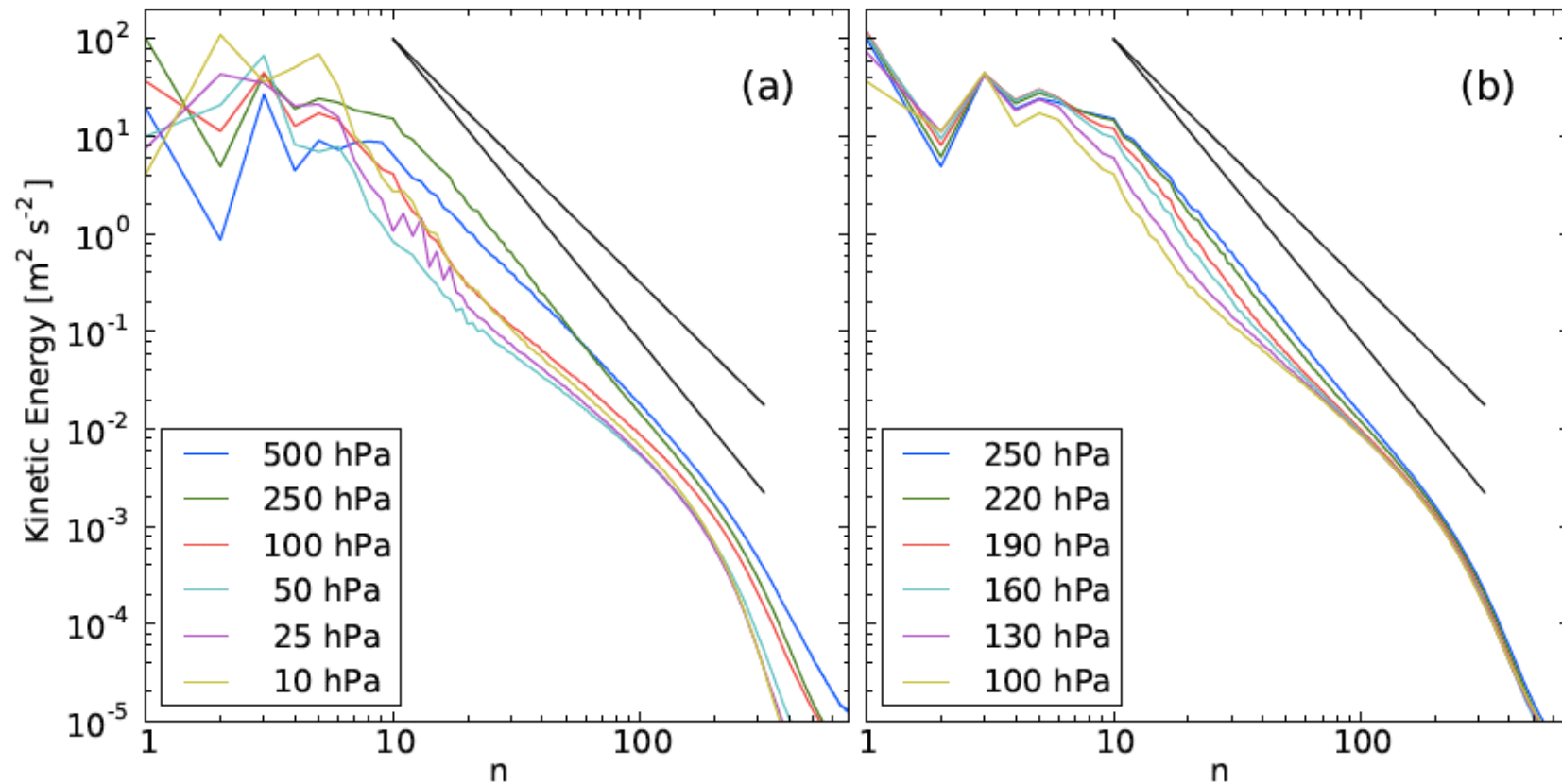

Burgess, Ertler & Shepherd (JAS, in press)

- The power-law scaling in these spectra is remarkable!
- The mesoscale spectral slope is considerably steeper than $-5/3$, but the *divergent* kinetic energy has a $-5/3$ slope

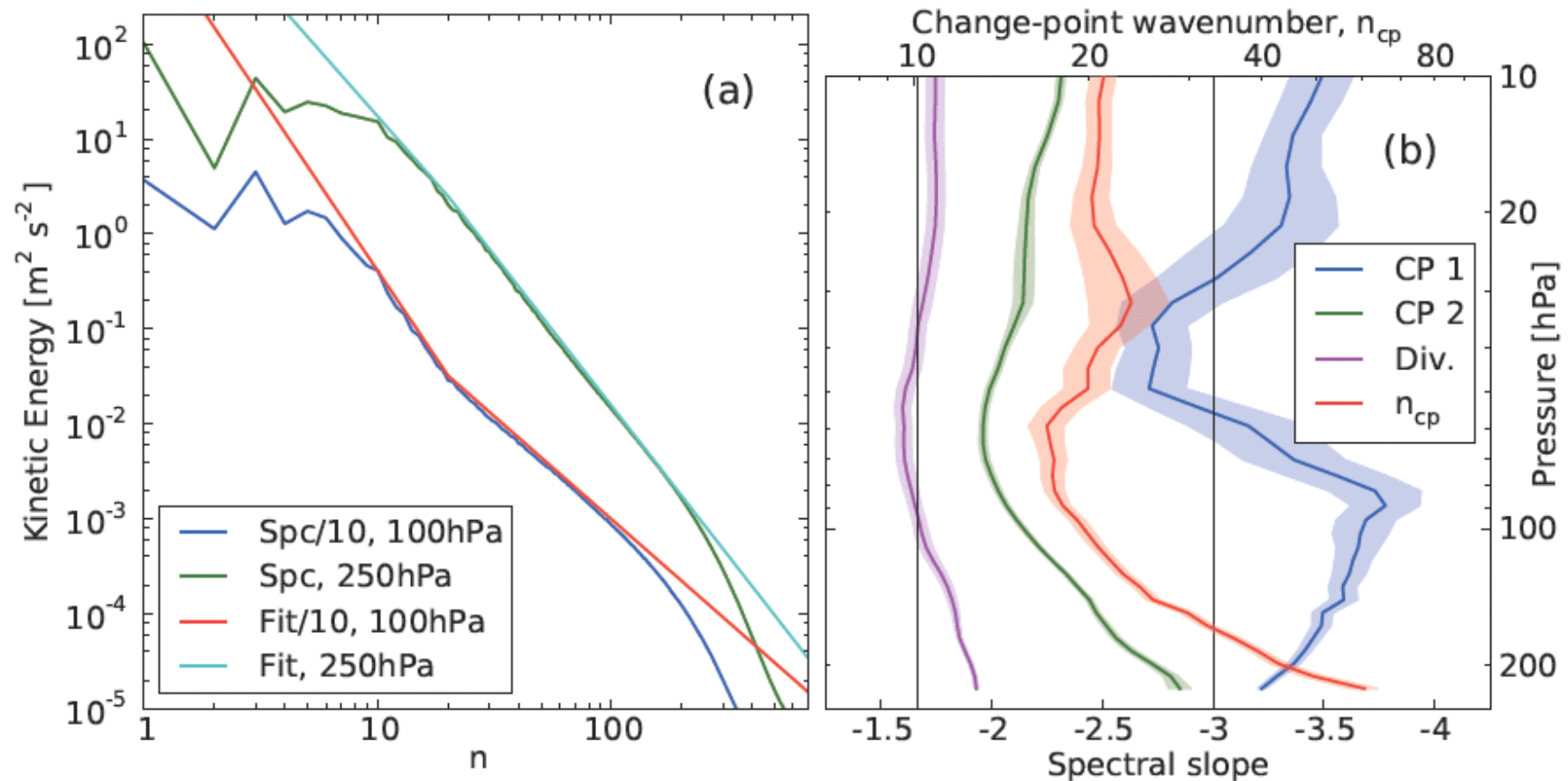

Burgess, Eler & Shepherd (JAS, in press)

- The spectral break reflects the dominance of the divergent (unbalanced) component of the flow at the smaller scales; the divergent component grows with altitude, and the spectral break moves upscale

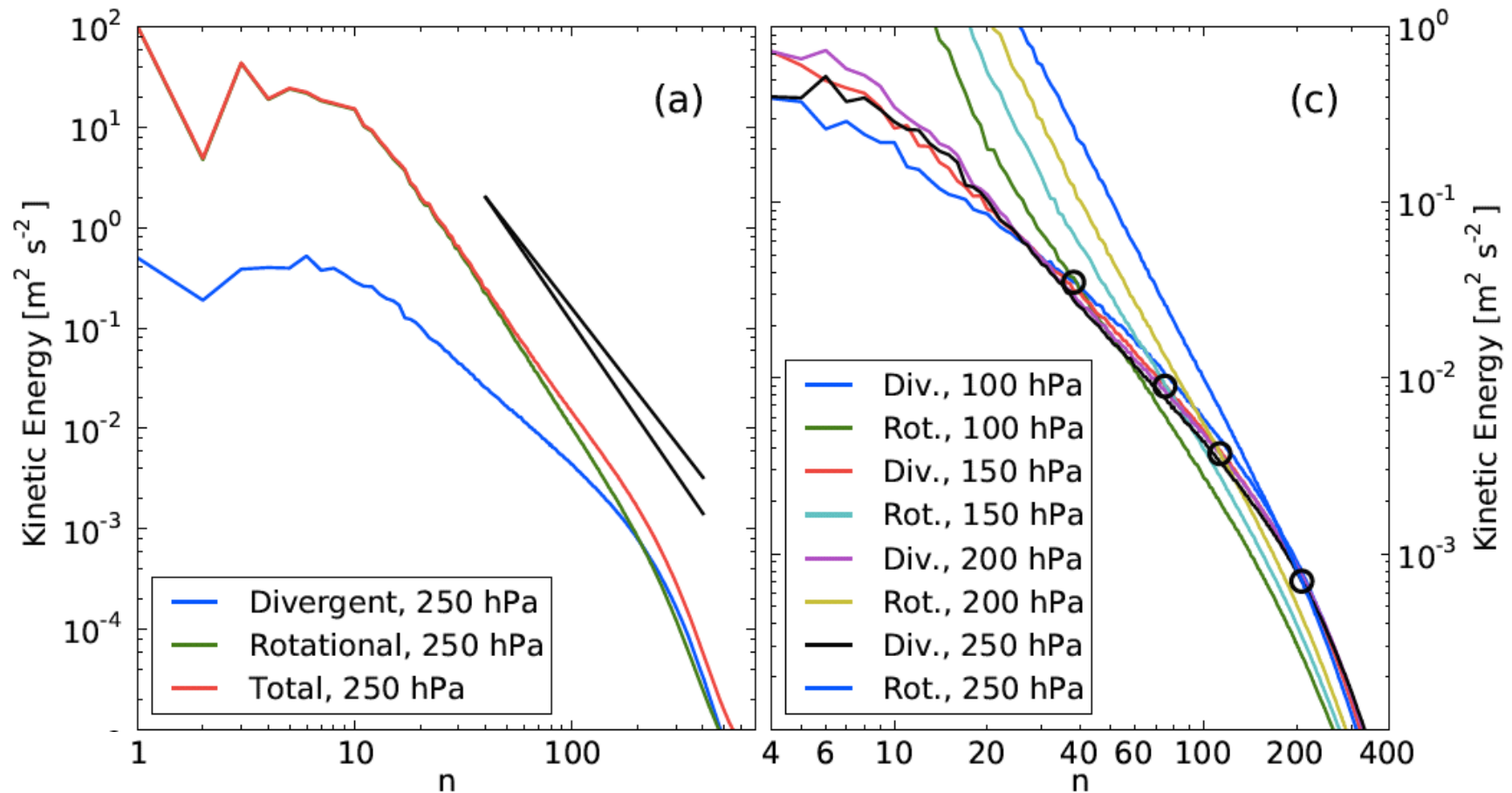

Burgess, Eler & Shepherd (JAS, in press)

- In T1279 forecasts, the mesoscale spectrum extends to higher wavenumbers and the slope is closer to $-5/3$
 - The dissipation range begins around $n=200$!

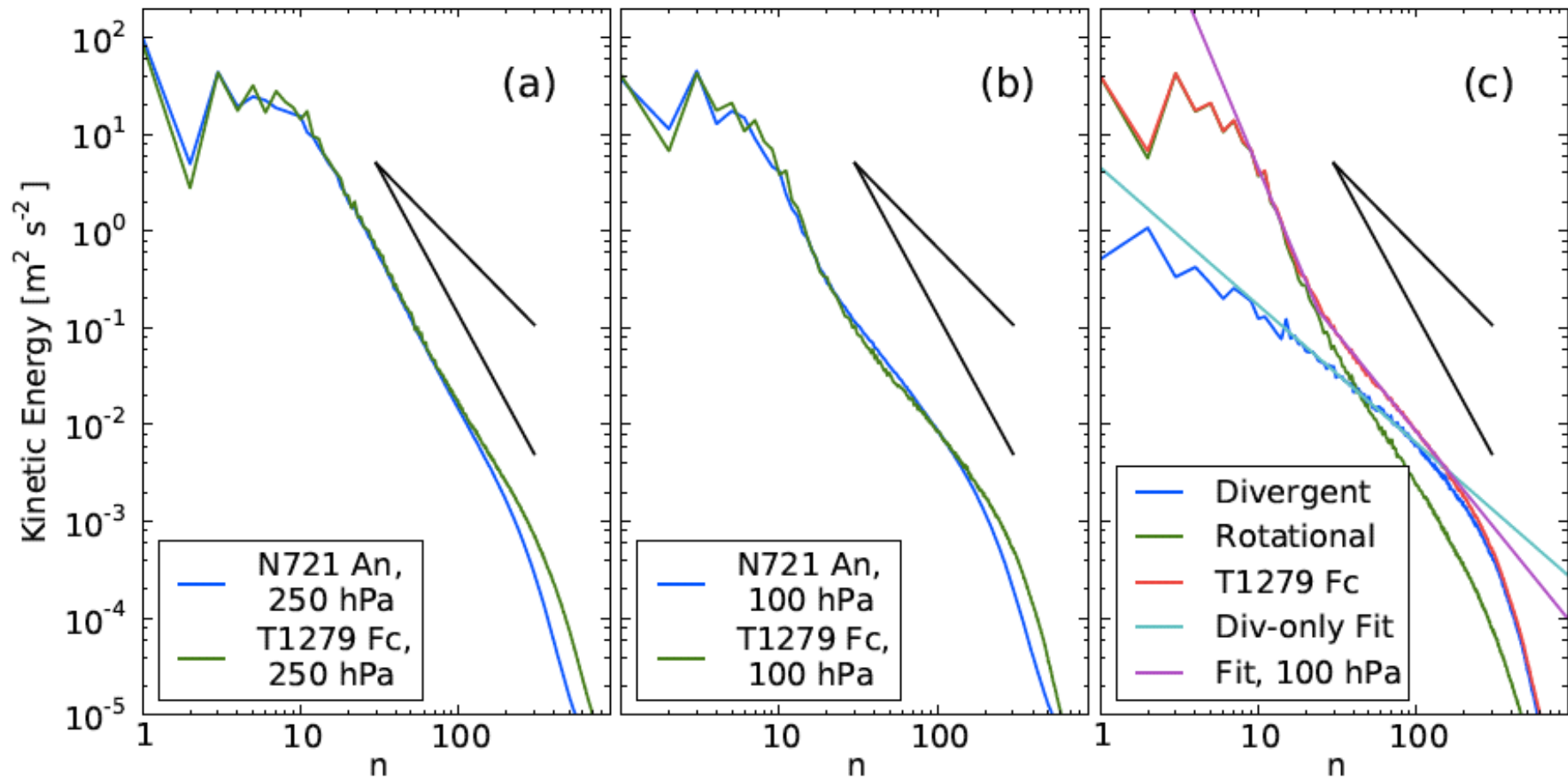

Burgess, Eler & Shepherd (JAS, in press)

Summary

- The upscale energy cascade seen in atmospheric observations is associated with wave-mean interactions, and the direction of the “cascade” is not inevitable
 - Depends on relation between the midlatitude/subtropical jet and the baroclinic zone, and the role of low-frequency, barotropic eddies
 - Baroclinic excitation occurs over $n=10-30$
- The origin of the n^{-3} spectral range remains unclear, but seems robustly associated with geostrophic turbulence
- The n^{-3} spectral range gives way to a $n^{-5/3}$ range around 500 km, which appears to be associated with a downscale cascade of unbalanced energy
 - Seen in recent operational ECMWF analyses
 - Implications of this for subgrid-scale parameterization remain to be explored

Reference1

- Boer, G. J., Shepherd, T. G., 1983: Large-Scale Two-Dimensional Turbulence in the Atmosphere, *J. Atmos. Sci.*, 40, 164-184
- Burgess, B. H., Erler, A. R., Shepherd, T. G., in press: The troposphere-to-stratosphere transition in kinetic energy 2 spectra and nonlinear spectral fluxes as seen in ECMWF analyses, *J. Atmos. Sci.*, 49pp
- Cummins, P. F., Holloway, G., 2010: Reynolds stress and eddy viscosity in direct numerical simulations of sheared twodimensional turbulence, *J. Fluid Mech.*, 657, 394-412
- Hamilton, K., Takahashi, Y. O., Ohfuchi, W., 2008: Mesoscale spectrum of atmospheric motions investigated in a very fine resolution global general circulation model, *J. Geophys. Res.*, 113, D18110
- Koshyk, J. N., Boer, G. J., 1995: Parameterization of Dynamical Subgrid-Scale Processes in a spectral GCM, *J. Atmos. Sci.*, 52, 965-976

Reference2

- Lorenz, E. N., 1967: The Nature and Theory of the General Circulation in the Atmosphere, W.M.O., Geneva, 161pp
- Nastrom, G. D., Gage, K. S., 1985: A Climatology of Atmospheric Wavenumber Spectra of Wind and Temperature Observed by Commercial Aircraft, J. Atmos. Sci., 42, 950-960
- O'Gorman, P. A., Schneider, T., 2007: Recovery of atmospheric flow statistics in a general circulation model without nonlinear eddy-eddy interactions, Geophys. Res. Lett., 34, L22801
- Shepherd, T. G., 1987: A Spectral View of Nonlinear Fluxes and Stationary-Transient Interaction in the Atmosphere., J. Atmos. Sci., 44, 1166-1179
- Shepherd, T. G., 1987: Rossby waves and two-dimensional turbulence in a large-scale zonal jet, J. Fluid Mech., 183, 467-509
- Shepherd, T. G., Koshyk, J. N., Ngan, K., 2000: On the nature of large-scale mixing in the stratosphere and mesosphere, J. Geophys. Res., 105, 12433-12446

Reference3

- Trenberth, K. E., Solomon, A., 1993: Implications of Global Atmospheric Spatial Spectra for Processing and Displaying Data, J. Climate, 6, 531-545
- Vallis, G. K., 2006: Atmospheric and Oceanic Fluid Dynamics, Cambridge University Press, 770pp
- Whitehead, J. A., 1975: Mean flow generated by circulation on a β -plane: An analogy with the moving flame experiment, Tellus, 27, 358-364